

# pixhawk<sup>®</sup> 4 mini

The power of Pixhawk 4 in a compact form



## IN THE BOX

Pixhawk 4 mini autopilot



Pixhawk 4 GPS module

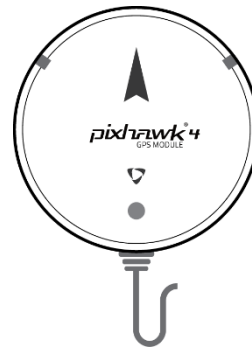

Power board

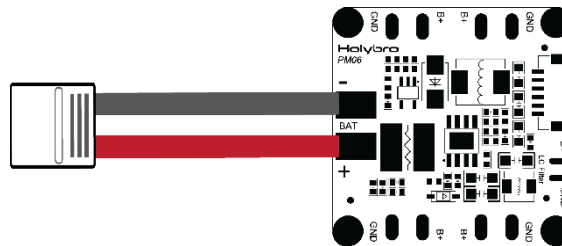

I2C splitter

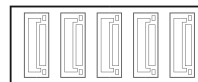

6 to 6 pin cable (power)

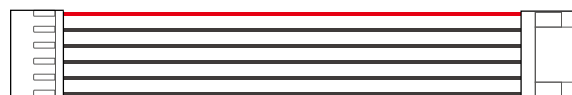

4 to 4 pin cable (CAN)



6 to 4 pin cable (Data)



6 to 4 pin and 4 pin “Y” cable

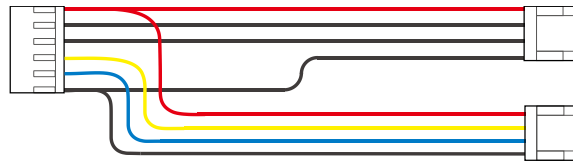

XSR receiver cable



DSMX receiver cable



PPM cable



USB Cable



## MOUNT

Use the provided foam pads to mount Pixhawk 4 Mini as close as possible to your vehicle's center of gravity. Orient the board top-side up with the arrow pointing towards the front of the vehicle.

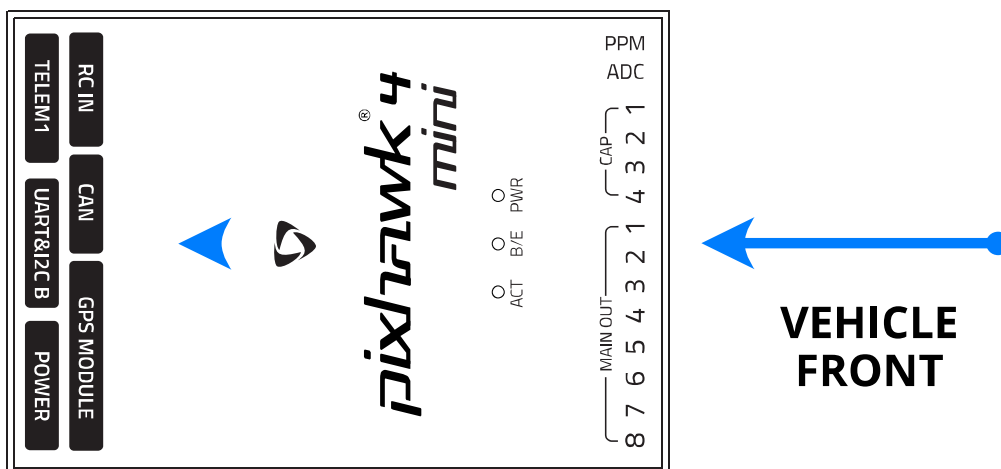

## CONNECT

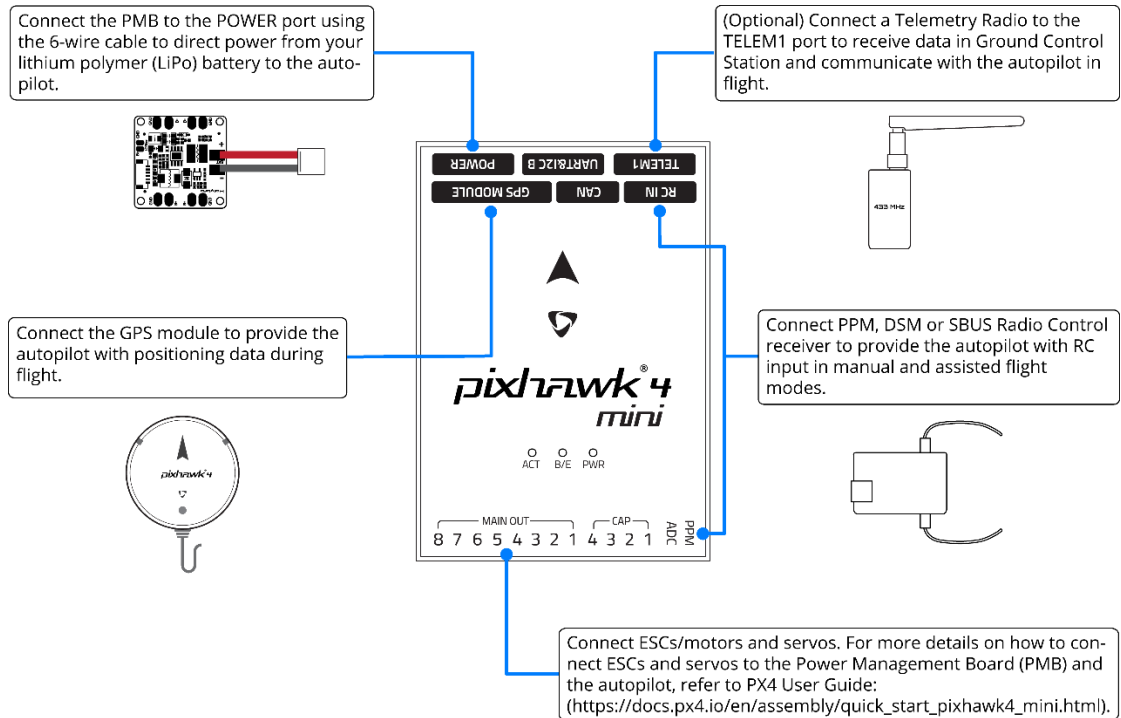

## SET UP

The PX4 firmware is the brains of your autopilot operation.

To configure your vehicle as well as do mission planning and flight monitoring, you can use the free QGroundControl application (Windows, Mac, Linux), which you can download from <http://qgroundcontrol.com/>

Once you have installed and successfully run QGroundControl, plug in Pixhawk 4 Mini with the supplied USB cable, it should be automatically recognized. Click on  and follow the on-screen instructions to finish the setup steps.

As part of a first time setup, you'll need to configure some of the required hardware components, such as:

- Frame type configuration
- Compass calibration
- Radio control calibration
- Accelerometer calibration
- RC transmitter mode setup
- ESC calibration

In addition to mandatory calibrations, you may also choose to configure optional hardware including battery monitor, sonar, airspeed sensor, optical flow, OSD, camera gimbal, antenna tracker etc.

## **ADDITIONAL INFORMATION**

Refer to [pixhawk.org](http://pixhawk.org) for detailed pinouts of Pixhawk 4 Mini.

Visit PX4 user guide at [px4.io](http://px4.io) for detailed instructions including tutorials on how to change firmware and do advanced configurations with QGroundControl.

Join PX4 Slack (<http://slack.px4.io/>) to receive support from the community and the PX4 team.

Holybro is a registered trademark of Holybro, registered in the U.S. and other countries.

©Copyright 2018 Holybro. All Rights Reserved.

Pixhawk and its logo are registered trademarks of Lorenz Meier. Used under license.

# pixhawk<sup>®</sup> 4 mini

Power Management Board

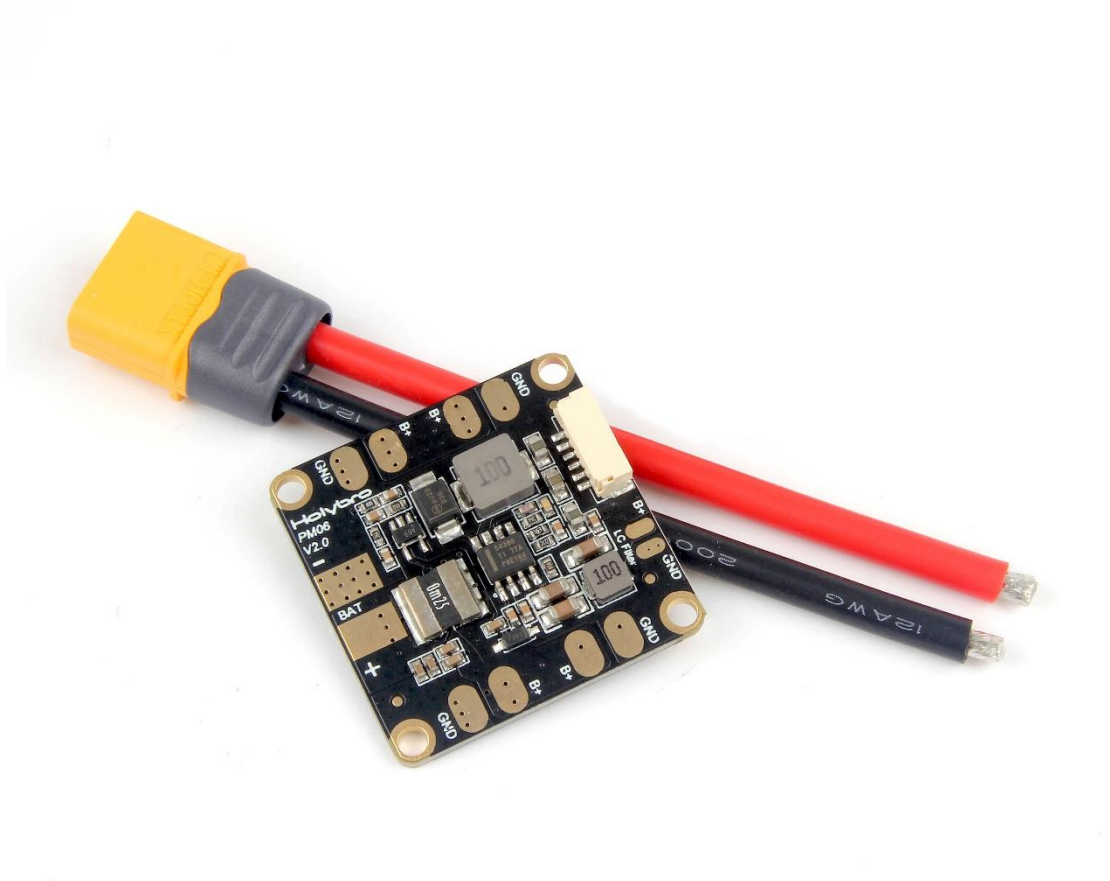

The Power Management Board (PMB) serves the purpose of a power module as well as a power distribution board. In addition to providing regulated power to Pixhawk 4 Mini and the ESCs, it sends information to the autopilot about the battery's voltage and current draw.

To power the Pixhawk 4 Mini connect the output of the PMB to the POWER port of the Pixhawk 4 Mini using a 6-wire cable. The connections of the PMB, including power supply and signal connections to the ESCs and servos, are explained in the image and table below.

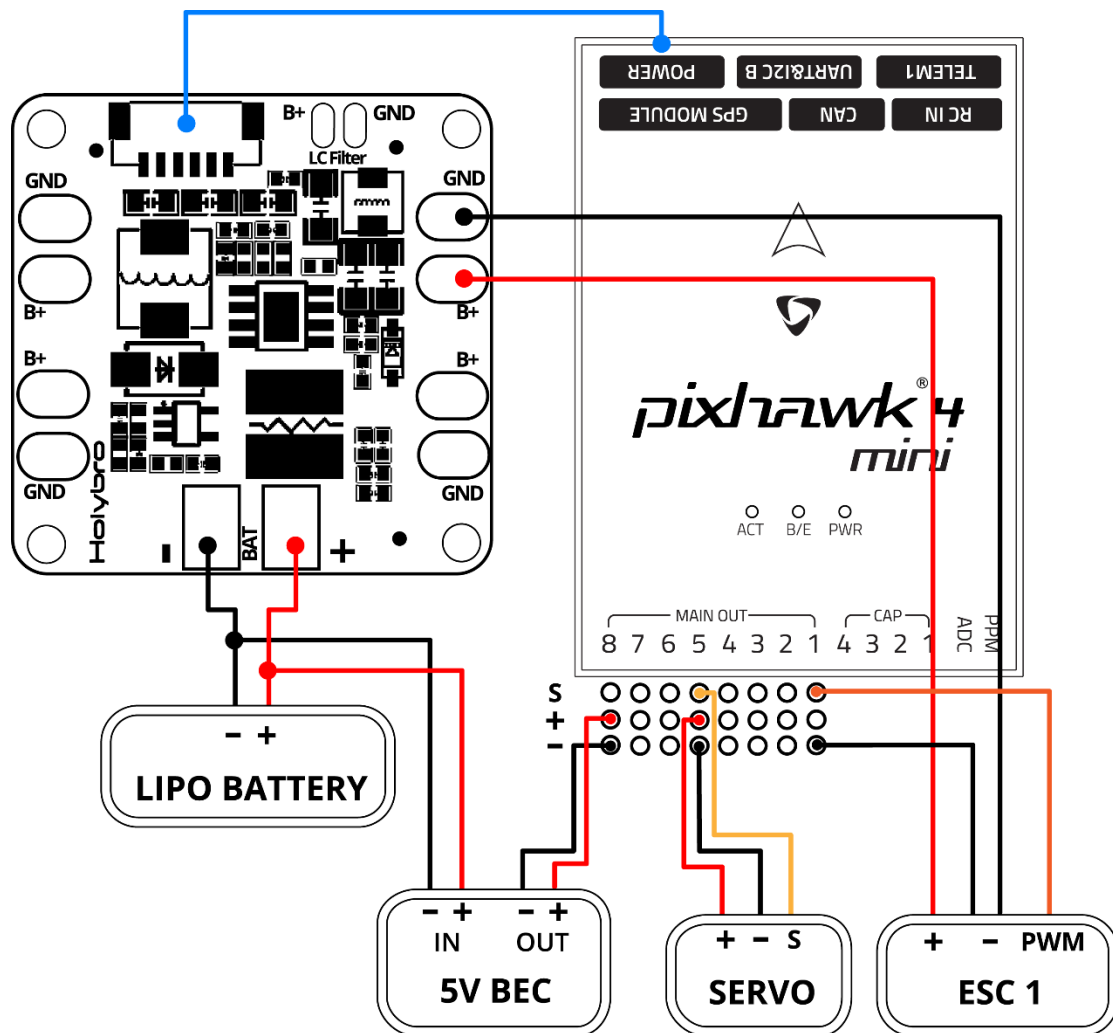

Note: The image above only shows the connection of a single ESC and a single servo. Connect the remaining ESCs and servos similarly. Refer to Airframe Reference ([https://docs.px4.io/en/airframes/airframe\\_reference.html](https://docs.px4.io/en/airframes/airframe_reference.html)) to connect ESCs to **MAIN OUT** in the correct order for your airframe configuration.

Power Management Board Pinout	
Pin(s) or Connector	Function
B+	Connect to ESC B+ to power the ESC
GND	Connect to ESC Ground
PWR	JST-GH 6-pin Connector, 5V 3A output Connect to <i>Pixhawk 4 Mini</i> POWER
BAT	Power Input Connect to 2~10s LiPo Battery

If using a plane or rover, the 8 pin power (+) rail of **MAIN OUT** will need to be separately powered in order to drive servos for rudders, elevons, etc. To do this, the power rail needs to be connected to a BEC equipped ESC, a standalone 5V BEC, or a 2S LiPo battery. Be careful with the voltage of servo you are going to use here.

The pinout of the Pixhawk 4 Mini **POWER** port is shown below. The CURRENT signal should carry an analog voltage from 0-3.3V for 0-120A as default. The VOLTAGE signal should carry an analog voltage from 0-3.3V for 0-60A as default. The VCC lines have to offer at least 3A continuous and should default to 5.1V. A lower voltage of 5V is still acceptable, but discouraged.

POWER port		
Pin	Signal	Voltage
1 (red)	VCC	+5V
2 (black)	VCC	+5V
3 (black)	CURRENT	+3.3V
4 (black)	VOLTAGE	+3.3V
5 (black)	GND	GND
6 (black)	GND	GND



## PIN MAP

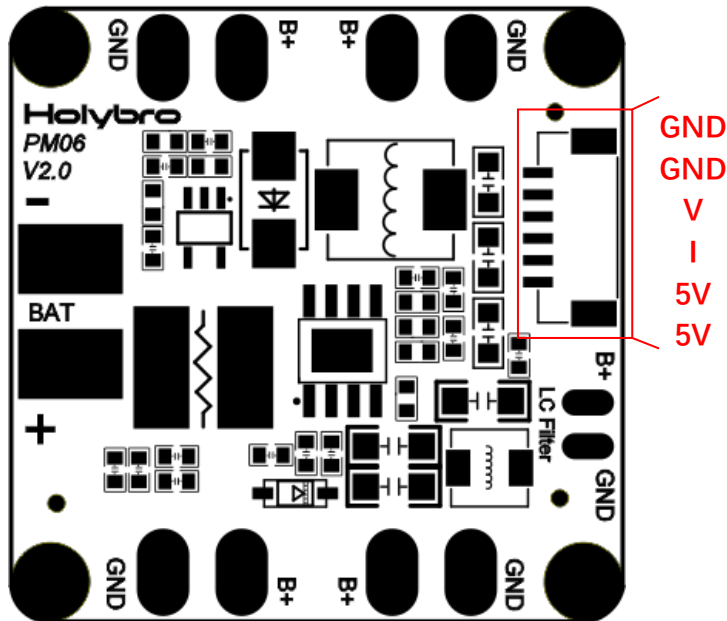

### Spec:

PCB Current: 120A continued

UBEC Current: 3A Max

Power input: DC 7V~42V(2S~10S)

Power output: DC 5.1V~5.3V

Dimensions: 35x35x5mm

Mounting hole: 30.5mm\*30.5mm

Weight: 7g

### Package Includes:

PM06 board x 1

XT60 connector wire x 1

Holybro is a registered trademark of Holybro, registered in the U.S. and other countries.

©Copyright 2018 Holybro. All Rights Reserved.

Pixhawk and its logo are registered trademarks of Lorenz Meier. Used under license.